

INSTALLATION AND MAINTENANCE



KB Eco2S Series Electronic Unit Heater



DANGER

ELECTRIC SHOCK OR FIRE HAZARD

READ ALL WIRE SIZING, VOLTAGE REQUIREMENTS AND SAFETY DATA TO AVOID PROPERTY DAMAGE AND PERSONAL INJURY

The ECO2S KB series unit heaters offers an energy efficient 2-stage heating, with ECO mode that automatically uses the lowest wattage needed to heat the room, integrated fan only and timer modes, as well as a remote control for simple operation. Designed for use as primary or supplemental heat sources in warehouses, stores or large garages spaces. Includes universal wall/ceiling bracket for simple installation.

⚠ WARNING ⚠

READ CAREFULLY - Use the heater only as described in this manual. Any other use is not recommended and could result in fire, electric shock, and personal injury. Following these instructions will prevent difficulties that might occur during the installation and use of the heater. Please study the instructions first, as they may save considerable time and trouble during use addition to providing important safety information. Make sure to save these instructions for future use.

- ⚠ WARNING** To prevent a possible electrical shock, disconnect all power coming to heater at main service panel before wiring or servicing.
- ⚠ WARNING** All wiring must be in accordance with the National Electrical Code (Canadian Electrical Code in Canada) and all applicable local codes. The heater must be grounded as a precaution against electrical shock. Supply wiring must be copper and suitable for at least 75° C.
- ⚠ WARNING** Verify power supply and control voltages coming to the heater match the ratings printed on the heater nameplate before energizing.
- ⚠ WARNING** Heater must be installed so the minimum clearances shown in Specifications table are maintained.
- ⚠ WARNING** This heater is NOT suitable for use in hazardous locations as described by the National Fire Protection Association (NFPA). this heater has hot and arcing or sparking parts inside. DO NOT use in areas where gasoline, paint or other flammable liquids are used or stored.
- ⚠ WARNING** The mounting structure and anchoring hardware MUST BE capable of reliably supporting the weight of the heater plus mounting bracket if used. Refer to specifications table for heater weight.
- ⚠ WARNING** Heater air flow MUST be directed parallel to or away from adjacent walls.
- ⚠ WARNING** To prevent a possible fire, DO NOT block air intakes or exhaust openings in any manner. DO NOT allow foreign objects to enter grill openings as this may cause electric shock, fire or damage to heater.
- ⚠ WARNING** Louver adjustment (Do not attempt to adjust while heater is operational): The Louvers are opened during testing at factory, but may have shifted during shipping, make sure the louvers are rotated less than 45 degrees from horizontal before operation. To adjust the opening angle, grasp the left and right end of louver and twist with two hands to the desired position. CAUTION: Increasing the angle beyond 45° degrees from horizontal may restrict air flow casing the over temperature limit to activate and shut off the heater.



**CAUTION—RISK OF ELECTRIC SHOCK
DO NOT OPEN HEATER SHELL**



KB ECO2S INSTALLATION

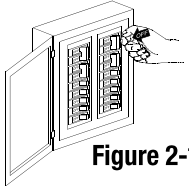

Figure 2-1

CAUTION!
Turn OFF all electrical power to install heater



Selecting A Location For Your Heater:

The heater should be installed out of the reach of persons. The direction of air flow should not be restricted by machinery, beams, columns or partitions, etc., and the air flow should wipe exposed walls rather than blowing directly at them.

Heaters should be directed away from room occupants in comfort heating and are directed along the windward side when installed in a building exposed to a prevailing wind.

Small rooms can be heated by one unit heater. Large rooms require multi-unit installations. Number and capacity of units will be determined by volume of building and square feet of floor area to be heated.

When more than one heater is used in an area the heaters should be arranged so that the air discharge of each heater supports the air flow of the others to provide best circulation of warm air.

(see air flow chart)

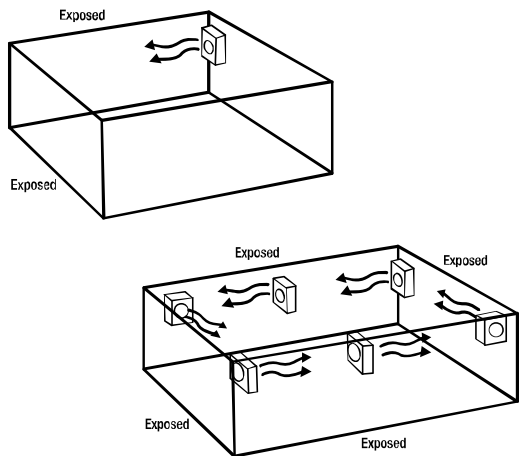

Unpack & Inspect Your New Heater

Remove heater from the box and inspect it for any damage. Verify you have received the universal wall/ceiling mounting bracket.

Tools Needed

You will need the following tools to install your unit heater:

- Screwdriver - (Phillips head & slotted)
- Wire Cutters
- Pliers
- Adjustable Wrench
- Electric Drill

Hardware Needed For Installation

You will also need the following hardware, which can be purchased from your local hardware store or electrical supply house:

- adequate gauge and length of wire for your application
- proper size fuses or breakers to handle amperage
- proper wire connectors for your application
- fasteners appropriate for application that are strong enough to hold unit

For certain applications conduit may be required. Check local electrical codes. Also, if you run the wiring in conduit and wish to be able to turn the heater, be sure to purchase enough flexible conduit to allow the heater to be turned.

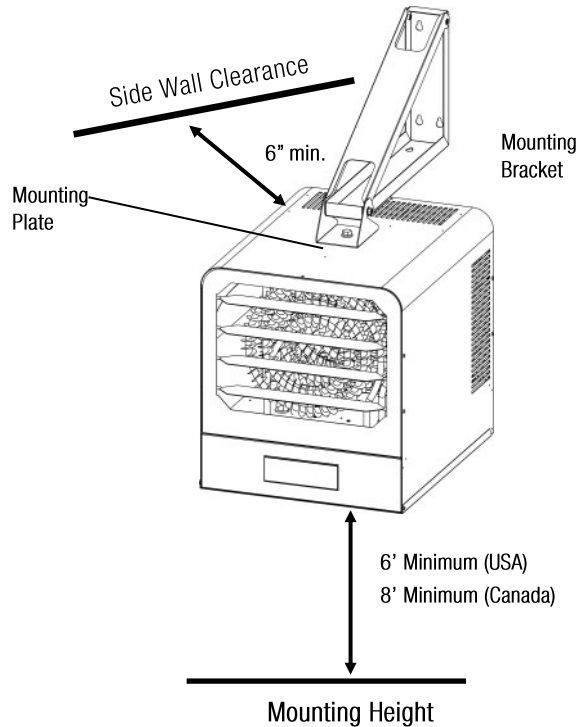

Mounting Height

When the airflow of the heater is directed vertically or horizontally the minimum mounting height of 6 feet above floor (8 feet above floor for Canada).

Mounting heights depend upon building utilization and heater kW capacity.

Distance From Vertical Side Walls

Be sure to maintain 6" minimum clearance to walls and ceilings.

INSTALLING U-MOUNTING BRACKET HOOK

Figure 1

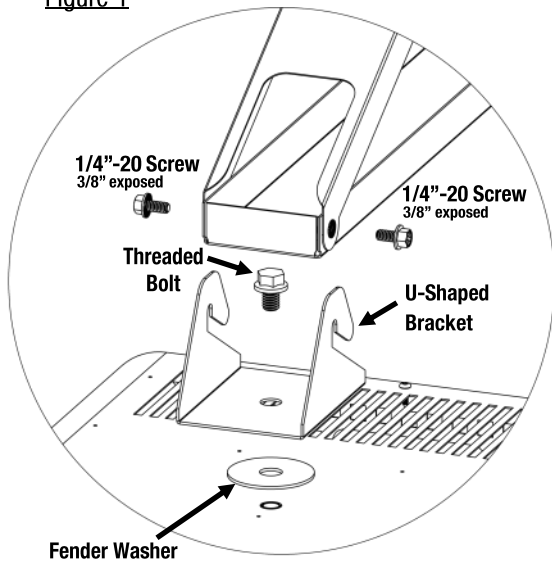

Installing U-Mounting Bracket Hook

The KB ECO2S Heater comes with U-Shaped bracket for installing the heater to the Ceiling/Wall bracket, allowing the heater to be quickly and easily installed.

1. Attached the U-shaped bracket to the heater by placing the large fender washer between the bracket and the heater so that it can rotate and then fasten it tightly using the threaded bolt provided in the hardware package.
2. Install the 2 pcs 1/4\"-20 machine screws into the Ceiling/Wall Bracket leaving them loose and leaving least 3/8\" of the shaft exposed.
3. Insert the hooks of the U-shaped bracket onto the exposed 1/4\"-20 machine screws. This will hold the heater in place while the screws are being tighten. This two piece bracket design makes it quick and easy for one person to install and hang the heater. (Refer to Figure 1).

INSTALLING CEILING/WALL MOUNTING BRACKET

Installing the Ceiling/Wall Mounting Bracket

Heater can be installed in either a Ceiling Mount or Wall Mount orientation. Locate a stud in ceiling or wall and securely fasten L-shaped mounting bracket to supporting surface with at least 2 fasteners strong enough to hold unit at least 1-1/4\" in length.

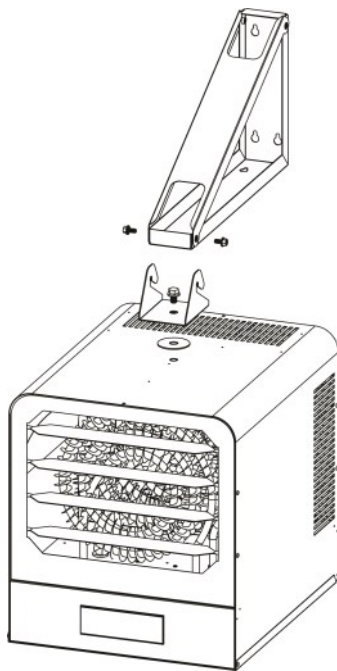

Wall Mount

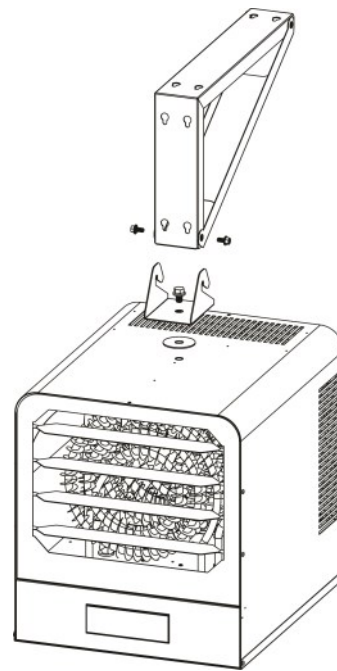

Ceiling Mount

WARNING
 Before proceeding further with the installation of this heater, turn off the power and lock to the supply line for the heater at the main service box.

WIRING DIAGRAM

Step 1: Remove wiring compartment cover.

Step 2: Remove one of the knockouts from back of unit.

Step 3: Select power supply wire to comply with local and national electric codes using heater rating given in table 1 below. Connect wire to heater as shown in wiring diagram attached to cover. Secure power supply cable with strain-relief clamps. Connect grounding conductor to green screw.

Step 4: Reinstall wiring compartment cover.

Step 5: Adjust the louvers to the desired position.

NOTE: The louvers are designed so they can not be completely closed. Do not attempt to defeat

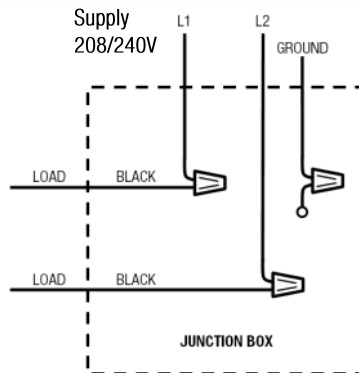

OPERATING INSTRUCTIONS

Operation



1. Push the  button, the heater will come on and heat to the default setting of 72°F.
2. Once the room temperature reaches the set point, the heat elements will turn off followed by a 3 minute fan delay period to exhaust excess heat from the case. Afterwards the unit will turn off.
3. In normal operation the display will show the current room temperature.

Automatic 2-stage HIGH/LOW operation



Eco2S controller offers energy efficient 2-stage heating, automatically using the lowest wattage required to heat the room.

- During operation, when the set temperature is within 3 degrees of the room temperature the heater automatically switches to ECO mode, operating at LOW wattage.



Room Temperature Selection

- During operation, push  or  arrow buttons to set the temperature from 45°F-95°F. Hold down the UP or DOWN arrow to speed up the selection process. The LCD will go back to display room temperature after 5 seconds.

Timer Mode Selection

- During operation, press the  button 1 time, the display window will show the timer mode setup. Push  or  to set Timer from 1 hour—9 hours.

Fan Only Mode Selection

- During operation, press the  button 2 times, the display window will show [H] (Heat Mode) or [F] (Fan Only Mode).
 Push  or  to switch between Fan Only and Heat modes.

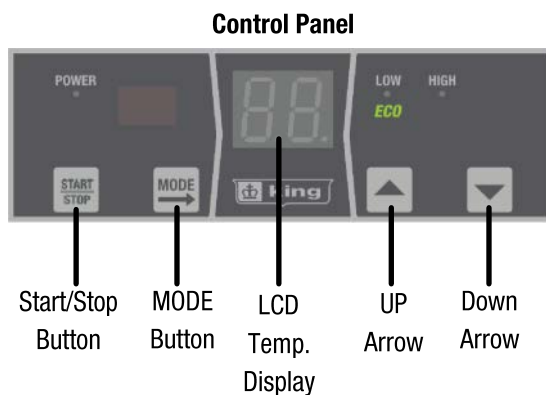

OPERATING INSTRUCTIONS CONTINUED

Display Lock Feature

Display Lock is designed for high traffic areas and deactivates the heater display buttons to prevent unwanted temperature adjustments. However settings can still be adjusted through the remote control.

- During operation, press the  button and HOLD for 5 seconds to set the display lock. [L] will appear on the display temporarily if a user attempts to make a temperature adjustment. While in Display Lock, heater can be adjusted using remote control.

Factory Reset

- During operation, press and HOLD the  button for 5 seconds to reset to the factory settings. [FA] will flash on the display.

Sensor Error Code

- During operation, if the display shows [E1] that indicates an issue with the sensor and the sensor needs to be replaced. Contact customer support for assistance.

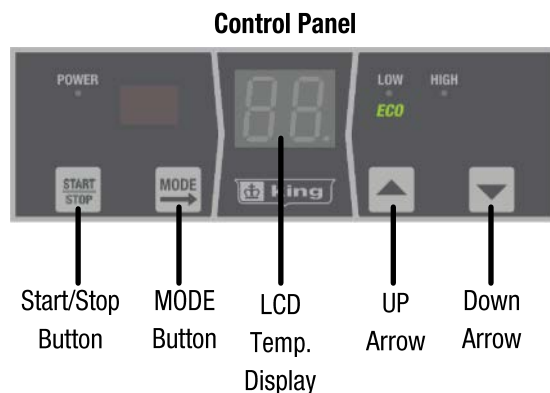

SMART LIMIT PROTECTION



This heater is equipped with a thermal overload Smart Limit Protection which disconnects elements and motor in the event normal operating temperatures are exceeded. If thermal overload trips due to abnormal operating temperatures, thermal overload shall remain open until manually reset by turning the heater OFF for fifteen minutes. Inspect for any objects on or adjacent to the heater that may cause high temperatures. If the SLP thermal protector shuts the heater off again, immediately turn the heater OFF at the circuit breaker and inspect the heater for possible fan motor failure or dirt and lint on the heating element. Repeat the starting procedure. **DO NOT TAMPER OR REMOVE THIS THIS DEVICE.**

LOUVER ADJUSTMENT TO DIRECT AIRFLOW

Louver Adjustment: (Do not adjust while heater is operational):

The Heater is shipped with louvers in the closed position and must be opened prior to use. Confirm louvers are rotated less than 45 degrees from horizontal before operation. To adjust the opening angle, grasp the left and right end of louver and twist with two hands to the desired position. CAUTION: Increasing angle beyond 45° degrees from horizontal may restrict air flow casing over temperature limit to activate & shut off the heater.

Louver Adjustment

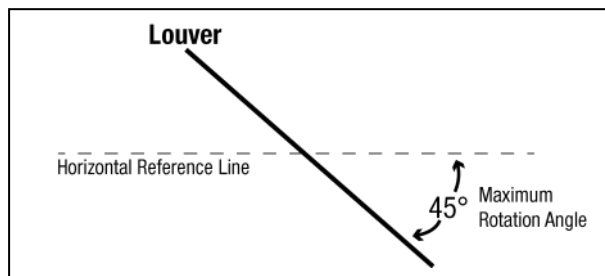

SMART LIMIT PROTECTION AND MAINTENANCE

Heater Safety Limit Tripped?



This heater is equipped with a thermal overload Smart Limit Protection which disconnects elements and motor in the event normal operating temperatures are exceeded. If thermal overload trips due to abnormal operating temperatures, thermal overload shall remain open until manually reset by turning the heater OFF for fifteen minutes. Inspect for any objects on or adjacent to the heater that may cause high temperatures. After inspecting the heater, keep the power to the heater off for 15 minutes to reset the SLP thermal protector. If the SLP thermal protector shuts the heater off again, immediately turn the heater OFF at the circuit breaker and inspect the heater for possible fan motor failure or dirt and lint on the heating element. Repeat the starting procedure.

DO NOT TAMPER OR REMOVE THIS THIS DEVICE

Maintenance

With proper care your electric heater should last a lifetime, however, seasonal cleaning is recommended to maintain the efficiency of the heater. Keep heating element, fan and motor free of debris. Use compressed air to blow out any debris.

We're Here to Help!

For any difficulties installing or operating this product

Call Us Toll Free at:

1-800-603-5464 Ext 111

7:00 am -3:30 pm PST Mon-Fri

Visit king-electric.com or email us at info@king-electric.com



KING ELECTRIC MFG CO · 9131 10TH AVENUE SOUTH ·
SEATTLE, WA 98108 · PH:206 762 0400 · FAX: 206 763 7738
·www.king-electric.com