

INSTALLATION AND MAINTENANCE



KB **PLATINUM** Series Electronic Unit Heater



DANGER

ELECTRIC SHOCK OR FIRE HAZARD

READ ALL WIRE SIZING, VOLTAGE REQUIREMENTS AND SAFETY DATA TO
 AVOID PROPERTY DAMAGE AND PERSONAL INJURY

⚠️ WARNING ⚠️

READ CAREFULLY - Use the heater only as described in this manual. Any other use is not recommended and could result in fire, electric shock, and personal injury. Following these instructions will prevent difficulties that might occur during the installation and use of the heater. Please study the instructions first, as they may save considerable time and trouble during use addition to providing important safety information. Make sure to save these instructions for future use.

- ⚠️ WARNING** To prevent a possible electrical shock, disconnect all power coming to heater at main service panel before wiring or servicing.
- ⚠️ WARNING** All wiring must be in accordance with the National Electrical Code (Canadian Electrical Code in Canada) and all applicable local codes. The heater must be grounded as a precaution against electrical shock. Supply wiring must be copper and suitable for at least 75° C.
- ⚠️ WARNING** Verify power supply and control voltages coming to the heater match the ratings printed on the heater nameplate before energizing.
- ⚠️ WARNING** Heater must be installed so the minimum clearances shown in Specifications table are maintained.
- ⚠️ WARNING** This heater is NOT suitable for use in hazardous locations as described by the National Fire Protection Association (NFPA). this heater has hot and arcing or sparking parts inside. DO NOT use in areas where gasoline, paint or other flammable liquids are used or stored.
- ⚠️ WARNING** The mounting structure and anchoring hardware **MUST BE** capable of reliably supporting the weight of the heater plus mounting bracket if used. Refer to specifications table for heater weight.
- ⚠️ WARNING** Heater air flow **MUST** be directed parallel to or away from adjacent walls.
- ⚠️ WARNING** To prevent a possible fire, DO NOT block air intakes or exhaust openings in any manner. DO NOT allow foreign objects to enter grill openings as this may cause electric shock, fire or damage to heater.
- ⚠️ WARNING** Louver adjustment (Do not attempt to adjust while heater is operational): The Louvers are opened during testing at factory, but may have shifted during shipping, make sure the louvers are rotated less than 45 degrees from horizontal before operation. To adjust the opening angle, grasp the left and right end of louver and twist with two hands to the desired position. CAUTION: Increasing the angle beyond 45° degrees from horizontal may restrict air flow causing the over temperature limit to activate and shut off the heater.



**CAUTION—RISK OF ELECTRIC SHOCK
DO NOT OPEN HEATER SHELL**



KB PLATINUM INSTALLATION

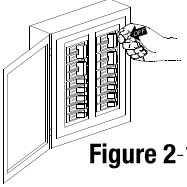

Figure 2-1

CAUTION!
Turn OFF all electrical power to install heater



Selecting A Location For Your Heater:

The heater should be installed out of the reach of persons. The direction of air flow should not be restricted by machinery, beams, columns or partitions, etc., and the air flow should wipe exposed walls rather than blowing directly at them.

Heaters should be directed away from room occupants in comfort heating and are directed along the windward side when installed in a building exposed to a prevailing wind.

Small rooms can be heated by one unit heater. Large rooms require multi-unit installations. Number and capacity of units will be determined by volume of building and square feet of floor area to be heated.

When more than one heater is used in an area the heaters should be arranged so that the air discharge of each heater supports the air flow of the others to provide best circulation of warm air.

(see air flow chart)

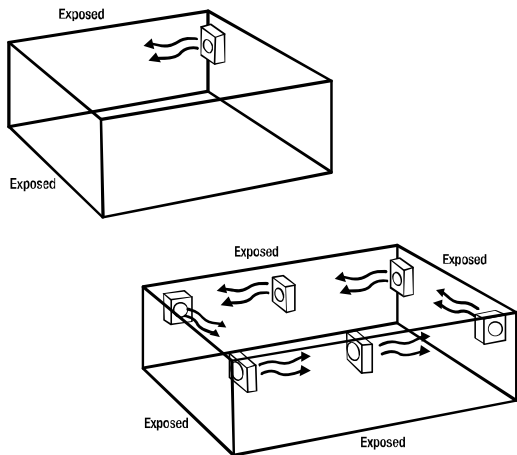

Unpack & Inspect Your New Heater

Remove heater from the box and inspect it for any damage. Verify you have received the universal wall/ceiling mounting bracket.

Tools Needed

You will need the following tools to install your unit heater:

- Screwdriver - (Phillips head & slotted)
- Wire Cutters
- Pliers
- Adjustable Wrench
- Electric Drill

Hardware Needed For Installation

You will also need the following hardware, which can be purchased from your local hardware store or electrical supply house:

- adequate gauge and length of wire for your application
- proper size fuses or breakers to handle amperage
- proper wire connectors for your application
- fasteners appropriate for application that are strong enough to hold unit

For certain applications conduit may be required. Check local electrical codes. Also, if you run the wiring in conduit and wish to be able to turn the heater, be sure to purchase enough flexible conduit to allow the heater to be turned.

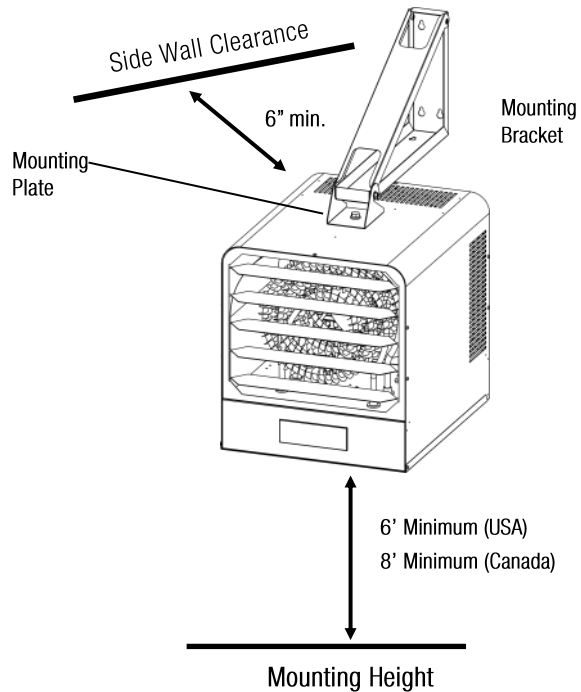

Mounting Height

When the airflow of the heater is directed vertically or horizontally the minimum mounting height of 6 feet above floor (8 feet above floor for Canada).

Mounting heights depend upon building utilization and heater kW capacity.

Distance From Vertical Side Walls

Be sure to maintain 6" minimum clearance to walls and ceilings.

KB PLATINUM INSTALLATION

⚠ **DANGER** ⚠

ELECTRIC SHOCK OR FIRE HAZARD

LINE VOLTAGE IS PRESENT ON SOME OF THE TERMINALS ON THE CONTROL TERMINAL BOARD. ALWAYS DISCONNECT THE POWER FROM THE HEATER BEFORE MAKING ANY CONNECTIONS TO THE CONTROL BOARD TO PREVENT ELECTRIC SHOCK HAZARD.



PLATINUM

KB PLATINUM WIRING

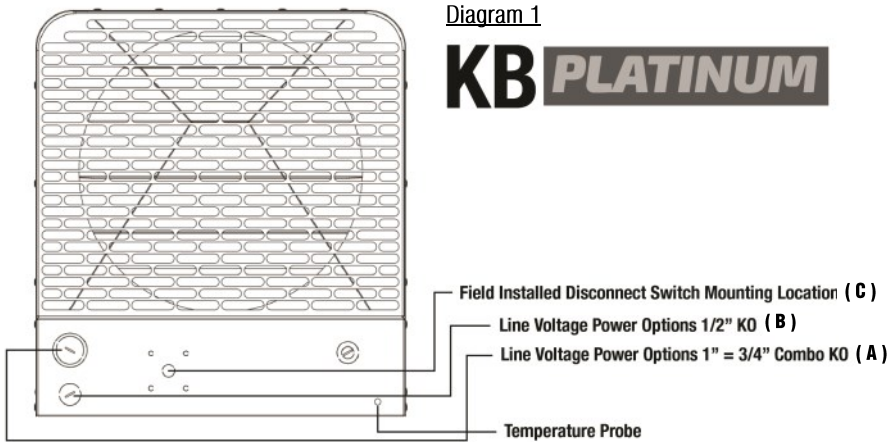

1. Connect heater to the voltage, and frequency specified on the nameplate.
2. Field wiring must be properly sized to carry the amperage of the heater in accordance with the NEC.
3. The electrical wiring compartment access door is hinged and has a screw on the bottom. Remove the screw to gain access.
4. Electrical knockouts (A and B) are provided on the back of the heater close to the power contactor. Use the diameter that fits the required conduit fitting size. See diagram 1 for more details.
5. A ground terminal is provided. The ground wire should be connected before other connections are made.
6. The power contactor is equipped with lugs to accept the power supply wire. Copper wire must be rated at 600 V and 60° C for the heater branch circuit.
7. Each heater has a wiring diagram affixed to the inside of the access door. Consult diagram before making any field connections.
8. Single or three-phase power connections may be used with heater models marked -3MP. These units are factory wired for single phase operation. If these heaters are for use with three-phased power, reconnect the wires as indicated in the wiring diagram attached to the heater.
9. Adjust the louvers to the desired position before operation.

Note: The mounting location for an optional field-installed disconnect switch (order separately) is shown above (C).

KB PLATINUM INSTALLATION

Installing the Ceiling/Wall Mounting Bracket

Heater can be installed in either a Ceiling Mount or Wall Mount orientation. Locate a stud in ceiling or wall and securely fasten L-shaped mounting bracket to supporting surface with at least 2 fasteners strong enough to hold unit at least 1-1/4" in length.

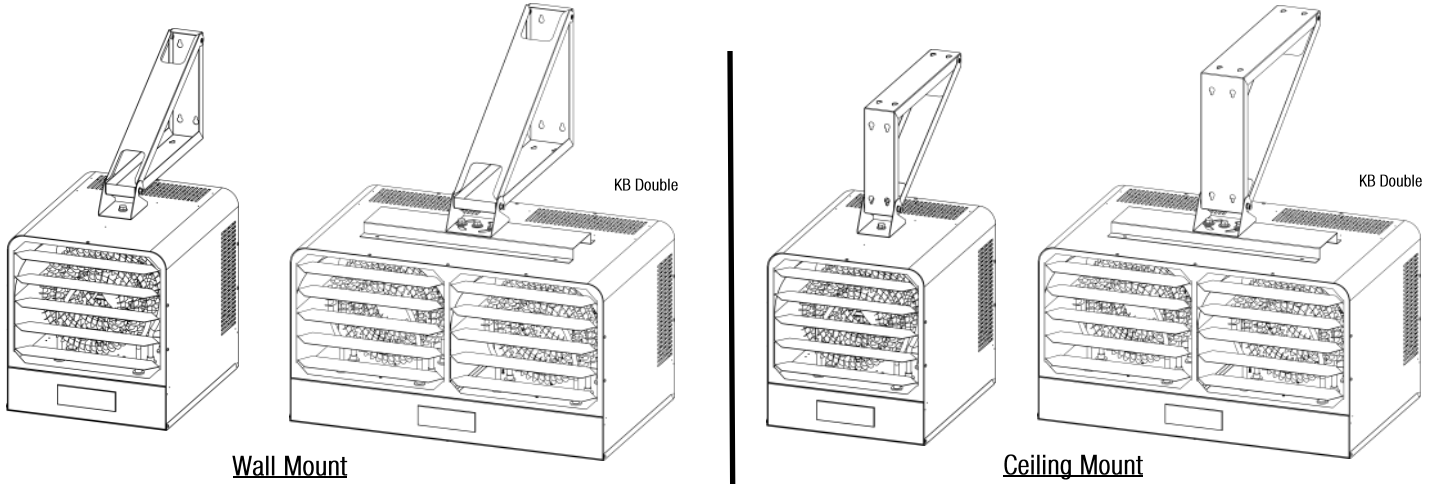
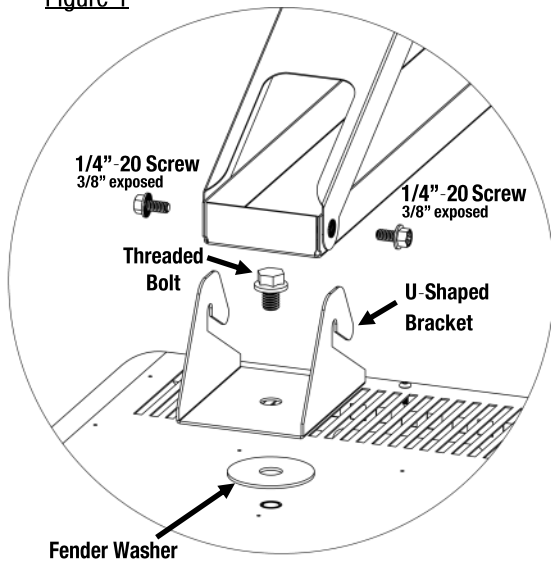

Figure 1



Installing U-Mounting Bracket Hook

The Platinum Heater comes with U-Shaped bracket for installing the heater to the Ceiling/Wall bracket, allowing the heater to be quickly and easily installed. KB Platinum Double Units require 2 Ceiling/Wall brackets.

1. Attached the U-shaped bracket to the heater by placing the large fender washer between the bracket and the heater so that it can rotate and then fasten it tightly using the threaded bolt provided in the hardware package.
2. Install the 2 pcs 1/4"-20 machine screws into the Ceiling/Wall Bracket leaving them loose and leaving least 3/8" of the shaft exposed.
3. Insert the hooks of the U-shaped bracket onto the exposed 1/4"-20 machine screws. This will hold the heater in place while the screws are being tighten. This two piece bracket design makes it quick and easy for one person to install and hang the heater. (Refer to Figure 1).

Louver Adjustment: (Do not adjust while heater is operational):

The Heater is shipped with louvers in the closed position and must be opened prior to use. Confirm louvers are rotated less than 45 degrees from horizontal before operation. To adjust the opening angle, grasp the left and right end of louver and twist with two hands to the desired position. CAUTION: Increasing angle beyond 45° degrees from horizontal may restrict air flow casing over temperature limit to activate & shut off the heater.

Louver Adjustment

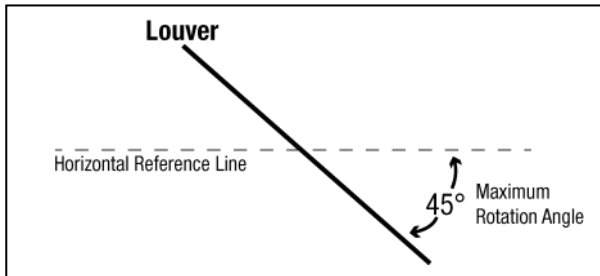

PLATINUM OPERATING INSTRUCTIONS

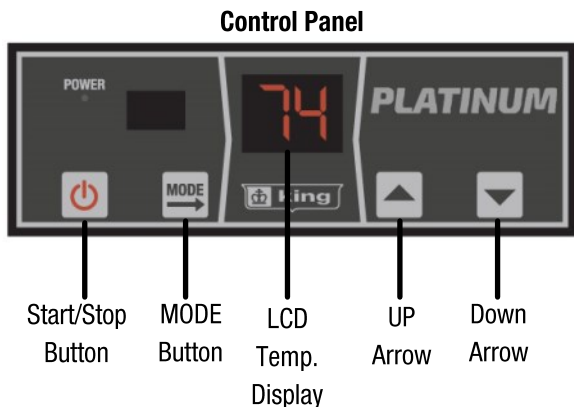



Infrared Remote Control

Operating Instructions

1. Push the  button, the heater will come on and heat to the default setting of 77°F.
2. Once the room temperature reaches the set point, the heater will stop running.
3. In normal operation the display will show the current room temperature.

Room Temperature Selection

- During operation, push  or  arrow buttons to set the temperature from 45°F-99°F, Hold down the UP or DOWN arrow to speed up the selection process. The LCD will go back to display room temperature after 5 seconds.

Indicator Lights Function:



- Indicator light 1 illuminates when the heater is in Heat Mode. Indicates the elements are ON.
- Indicator light 2 illuminates when room temperature reaches 3 degrees within the set point. This feature offers a quick indication that the room is approaching the desired comfort set temperature.

Timer Mode Selection

- During operation, press the  button 1 time, the display window will show the timer mode setup. Push the UP or DOWN arrows to set the timer from 1 hour—9 hours.

Fan Only Mode Selection

Lower thermostat temperature below the room temp. prior to Fan Only selection.

- During operation, press the  button 2 times, the display window will show H (Heat Mode) or F (Fan Only Mode). Push  to enter Fan Only mode. Push  to enter Heat Mode.

Display Lock Feature

Prevents unauthorized users from making temp. adjustments.

1. Press Start/Stop Button for 5 seconds to set Display Lock.
2. Display is OFF while in display lock mode.
3. Display shows **L.** temporarily if buttons are pressed.
4. Temp. settings can still be adjusted using the remote control.

Factory Reset

- During operation, press the and HOLD the  button for 5 seconds to reset to the factory settings.

Sensor Error Code

- During operation, if the display shows E1 that indicates an issue with the sensor. The sensor connector may have come loose from the control board. Open the wiring compartment and reseal the sensor onto the control board. Or it may be possible the sensor needs to be replaced. Contact customer support for assistance.

KB PLATINUM MODEL CHART

MODEL	VOLTS	kilo WATTS	PHASE	1-PH AMPS	3-PH AMPS
KB2003-1-P	208	3	1	14.4	-
KB2403-1-P	240	3	1	12.5	-
KB2703-1-P	277	3	1	10.8	-
KB2004-1-P	208	4	1	19.2	-
KB2404-1-P	240	4	1	16.7	-
KB2704-1-P	277	4	1	14.4	-
KB2005-1-P	208	5	1	24.0	-
KB2405-1-P	240	5	1	20.8	-
KB2705-1-P	277	5	1	18.1	-
KB2007-1-P	208	7.5	1	36.1	-
KB2407-1-P	240	7.5	1	31.3	-
KB2707-1-P	277	7.5	1	27.1	-
KB2010-1-P	208	9.98	1	48.0	-
KB2410-1-P	240	10	1	41.7	-
KB2710-1-P	277	10	1	36.1	-
KB2003-3MP-P	208	3	1-3	14.4	8.3
KB2403-3MP-P	240	3	1-3	12.5	7.2
KB2005-3MP-P	208	5	1-3	24.0	13.9
KB2405-3MP-P	240	5	1-3	20.8	12.0
KB2007-3MP-P	208	7.5	1-3	36.1	20.8
KB2407-3MP-P	240	7.5	1-3	31.3	18.1
KB2410-3MP-P	240	10	1-3	41.7	24.1
KB2010-3MP-P	208	9.98	3	48.0	27.7
KB2012-3-P	208	12.5	3	-	34.7
KB2412-3-P	240	12.5	3	-	30.1
KB2015-3-P	208	15	3	-	41.7
KB2415-3-P	240	15	3	-	36.1

MODEL	VOLTS	kilo WATTS	PHASE	1-PH AMPS	3-PH AMPS
KB2012-1-P-FB	208	12.5	1	60.1	-
KB2412-1-P-FB	240	12.5	1	52.1	-
KB2015-1-P-FB	208	15	1	72.1	-
KB2415-1-P-FB	240	15	1	62.5	-
KB2020-3-P-FB	208	20	3	-	55.6
KB2420-3-P-FB	240	20	3	-	48.2
KB2025-3-P-FB	208	25	3	-	69.5
KB2425-3-P-FB	240	25	3	-	60.2
KB2030-3-P-FB	208	30	3	-	83.4
KB2430-3-P-FB	240	30	3	-	72.3
KB2440-3-P-FB	240	40	3	-	96.3

SMART LIMIT PROTECTION AND MAINTENANCE



Heater Safety Limit Tripped?

This heater is equipped with a thermal overload Smart Limit Protection which disconnects elements and motor in the event normal operating temperatures are exceeded. If thermal overload

trips due to abnormal operating temperatures, thermal overload shall remain open until manually reset by turning the heater OFF for fifteen minutes. Inspect for any objects on or adjacent to the heater that may cause high temperatures. After inspecting the heater, keep the power to the heater off for 15 minutes to reset the SLP thermal protector. If the SLP thermal protector shuts the heater off again, immediately turn the heater OFF at the circuit breaker and inspect the heater for possible fan motor failure or dirt and lint on the heating element. Repeat the starting procedure.

DO NOT TAMPER OR REMOVE THIS THIS DEVICE

Maintenance

With proper care your electric heater should last a lifetime, however, seasonal cleaning is recommended to maintain the efficiency of the heater. Keep heating element, fan and motor free of debris. Use compressed air to blow out any debris.

We're Here to Help!

For any difficulties installing or operating this product

Call Us Toll Free at:

1-800-603-5464 Ext 111

7:00 am -3:30 pm PST Mon-Fri

Visit king-electric.com

or email us at info@king-electric.com